

目 录

一、运输作业组织与管理模块..... 2

二、仓储与配送作业组织与管理模块..... 34

三、国际物流作业组织与管理模块..... 150

四、 快递物流作业组织与管理模块.....	213
-----------------------	-----

湖南商务职业技术学院物流管理专业学生技能考核题库

一、运输作业组织与管理模块

○

○

○

--	--	--

○

○

--	--	--	--	--

() 任务描述

- :
-
-



<input type="checkbox"/> <input type="checkbox"/>				<input type="checkbox"/> <input type="checkbox"/>				
<input type="checkbox"/> <input type="checkbox"/>								
						<input type="checkbox"/> <input type="checkbox"/> <input type="checkbox"/> <input type="checkbox"/>		



() 任务描述:

-
-
-



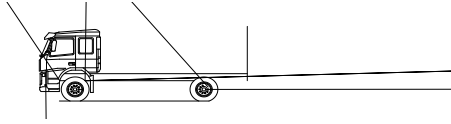

() 任务描述:



○

○

○

○

○

() 任务描述



D

<input type="checkbox"/> <input type="checkbox"/>			<input type="checkbox"/> <input type="checkbox"/>						
<input type="checkbox"/> <input type="checkbox"/>									
						<input type="checkbox"/> <input type="checkbox"/> <input type="checkbox"/> <input type="checkbox"/>			





2

3

4

() 任务描述



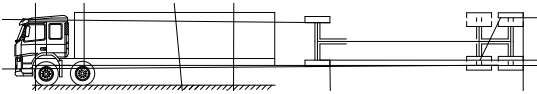
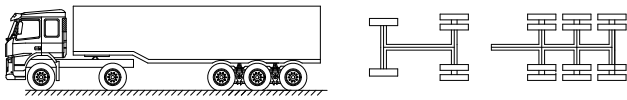
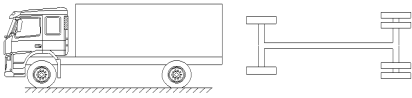



() 任务描述

-
-
-
-
-

() 任务描述

()

()

)	()		

()

()

()

()

()

○

()		

Sailing Schedule from : Shenzhen,Shenzhen,Guangdong,China

To : Los Angeles,Los Angeles,CA,United States

Origin City : Shenzhen,Shenzhen,Guangdong,China

Destination City : Los Angeles,Los Angeles,CA,United States

CY/DOOR

CY/DOOR

序列号	航线	船名	航次	截关时间	装货港	预计离港时间	实际离港时间	卸货港
1	YPSW	YM UNISON	59E	2016-04-22 17:00	Yantian	2016-04-25		Los Angeles
2	SEA	NORTHERN JAVELIN	002E	2016-04-23 12:00	Yantian	2016-04-27		Long Beach
3	AAS2	CMA CGM LIBRA	095TXE	2016-04-25 16:00	Yantian	2016-04-28		Long Beach
4	YPSW	YM UBIQUITY	22E	2016-04-29 17:00	Yantian	2016-05-02		Los Angeles
5	SEA	C SCL PUSAN	117E	2016-04-30 12:00	Yantian	2016-05-04		Long Beach
6	AAS2	CMA CGM COLUMBA	097TXE	2016-05-02 16:00	Yantian	2016-05-05		Long Beach
7	SEA	COSCO NINGBO	069W	2016-05-06 11:00	Yantian	2016-05-08		Long Beach
8	YPSW	YM UBERTY	50E	2016-05-06 17:00	Yantian	2016-05-09		Los Angeles
9	SEA	COSCO EXCELLENCE	027E	2016-05-07 12:00	Yantian	2016-05-11		Long Beach
10	AAS2	CMA CGM CENTAURUS	099TXE	2016-05-09 16:00	Yantian	2016-05-12		Long Beach
11	YPSW	YM MASCULINITY	32E	2016-05-13 17:00	Yantian	2016-05-16		Los Angeles
12	SEA	HONG KONG BRIDGE	039E	2016-05-14 12:00	Yantian	2016-05-18		Long Beach
13	AAS2	CMA CGM THALASSA	101TXE	2016-05-16 16:00	Yantian	2016-05-19		Long Beach



干货箱



	箱体内部尺寸			箱体内容积及载重量		箱门开度尺寸	
	L	W	H	Cu	P	W	H
20'	5898	2352	2393	33.2	21740/28230#	2340	2280
40'	12032	2352	2393	67.7	26630	2340	2280
HC	12032	2352	2698	76.3	26520	2340	2585

冷藏箱



	箱体内部尺寸			箱体内容积及载重量	
	L	W	H	Cu	P
20'	5444	2284	2267	28.5	21135/27160#
40'	11583	2284	2250	58.7	26580
HC	11583	2284	2659	67.9	26380

开顶箱



	箱体内部尺寸			箱体内容积及载重量	
	L	W	H	Cu	P
20'	5900	2330	2337	32.6	21740
40'	12025	2330	2337	65.8	26410



() 实施条件

() 考核时量

() 评分细则

1

() 任务描述



		<input type="checkbox"/>	<input type="checkbox"/>	<input type="checkbox"/>	<input type="checkbox"/>

□		□			
□		□			



() 实施条件

() 考核时量

() 评分细则

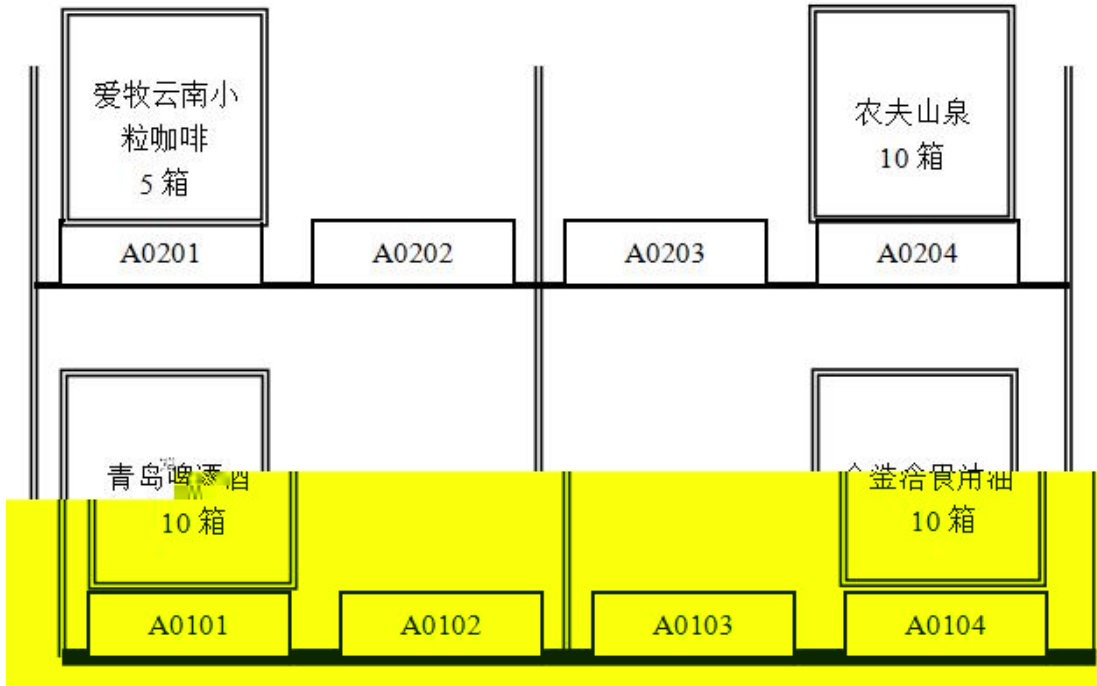

产品运输单

-
-
-
-
-
-
-
-

80				

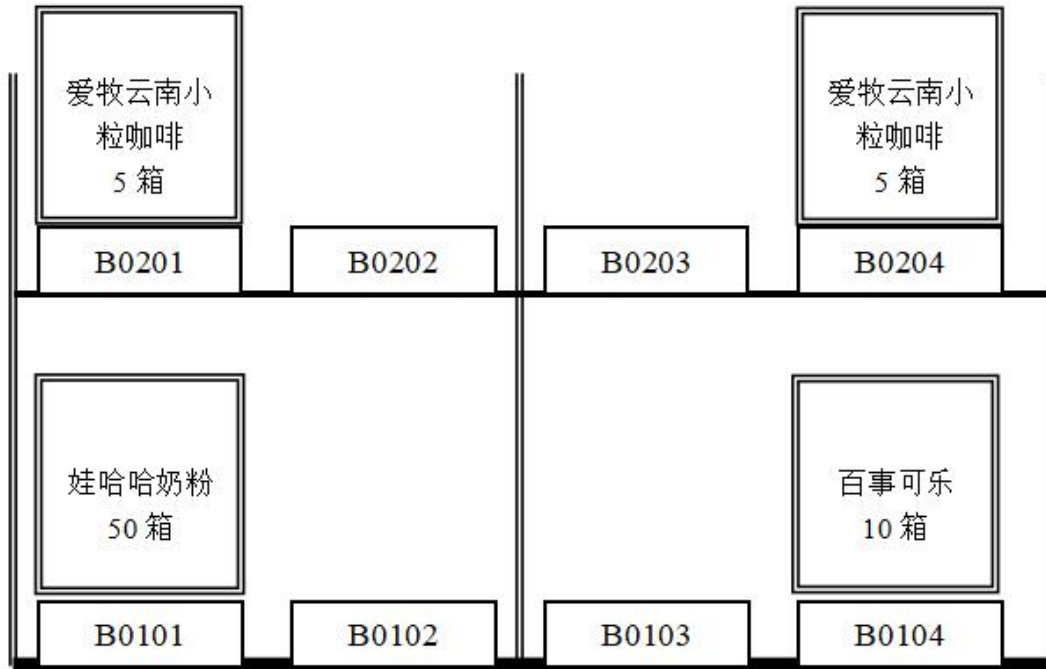
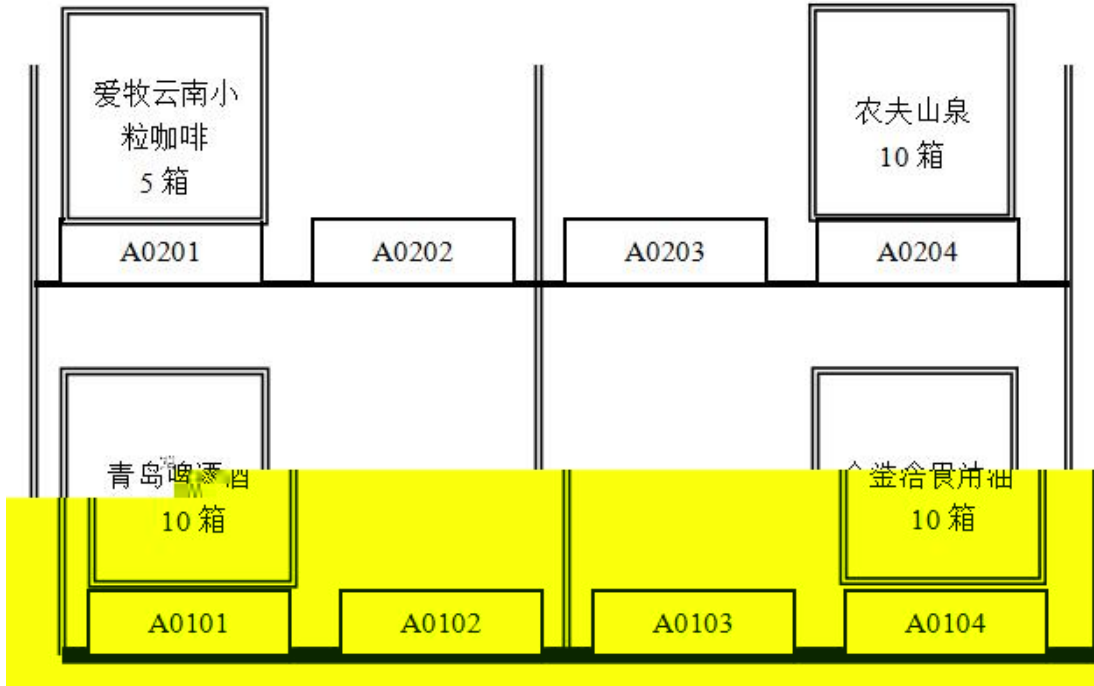

产品运输单

-
-
-
-
-
-
-
-

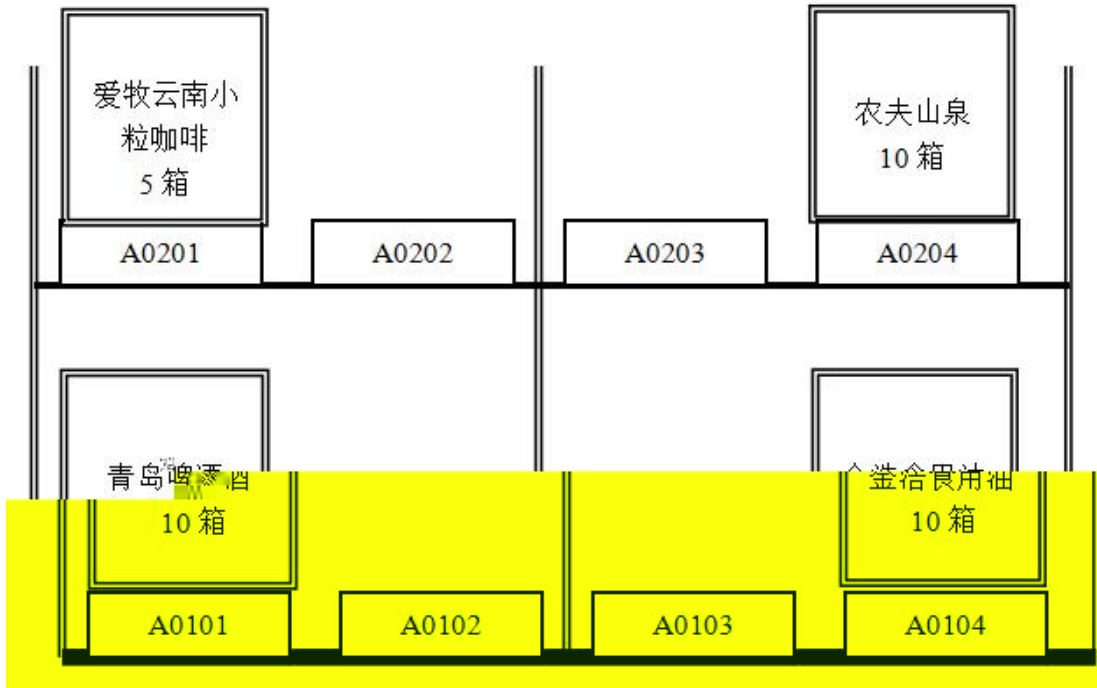

产品运输单



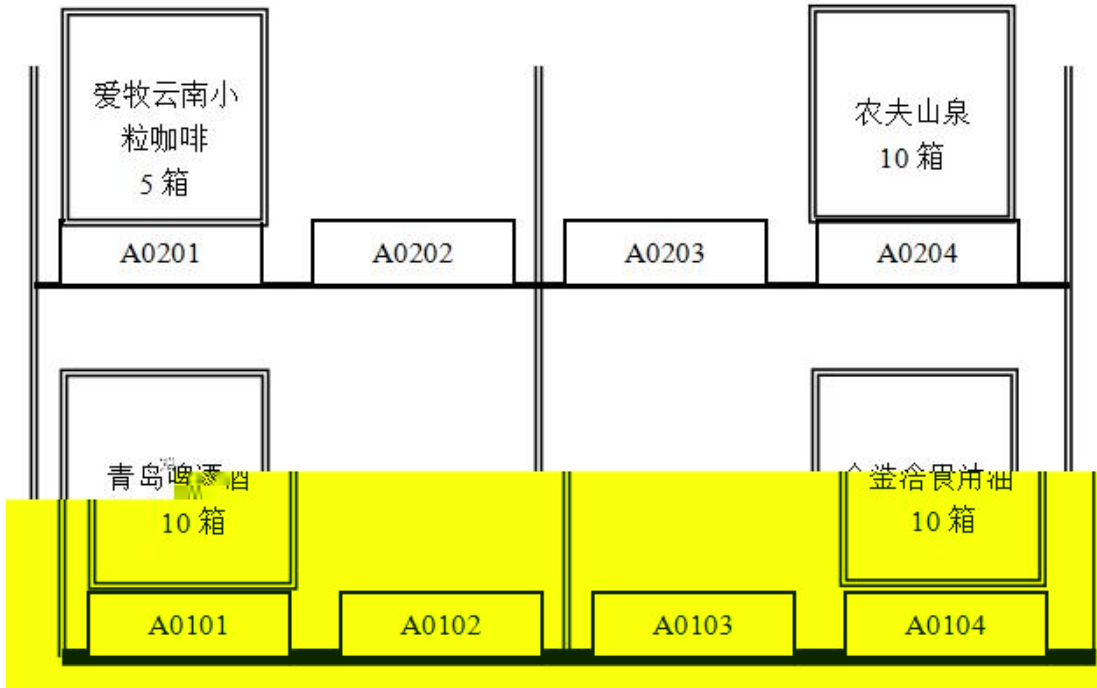

产品运输单

-
-
-
-
-
-
-
-

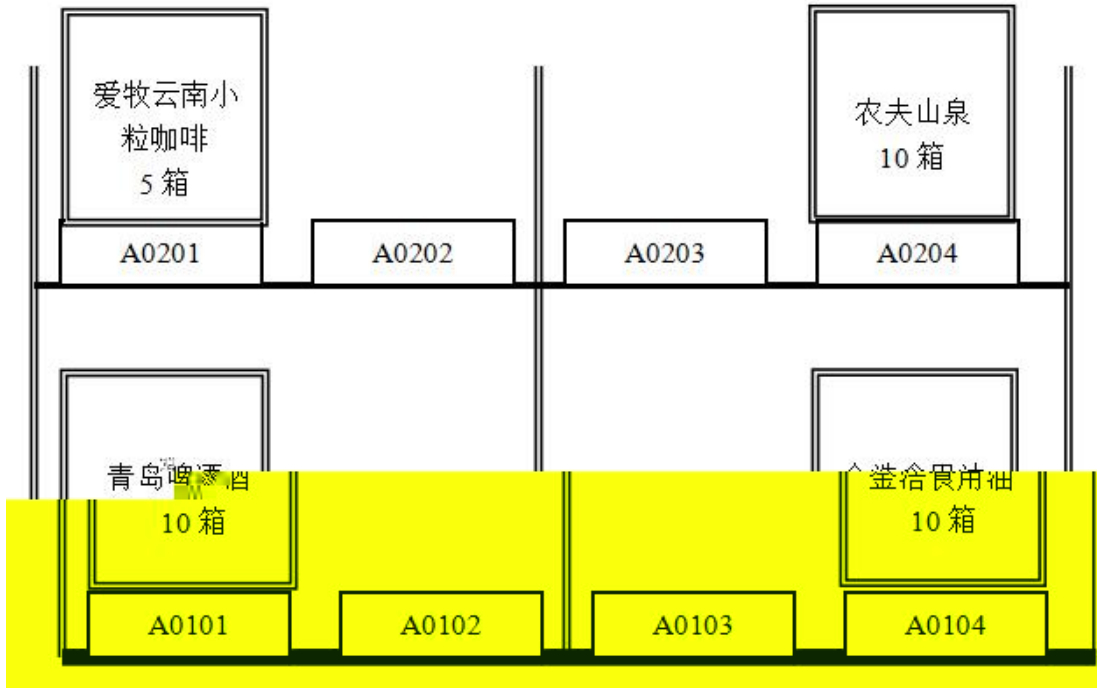

产品运输单

○

○

○

○

○

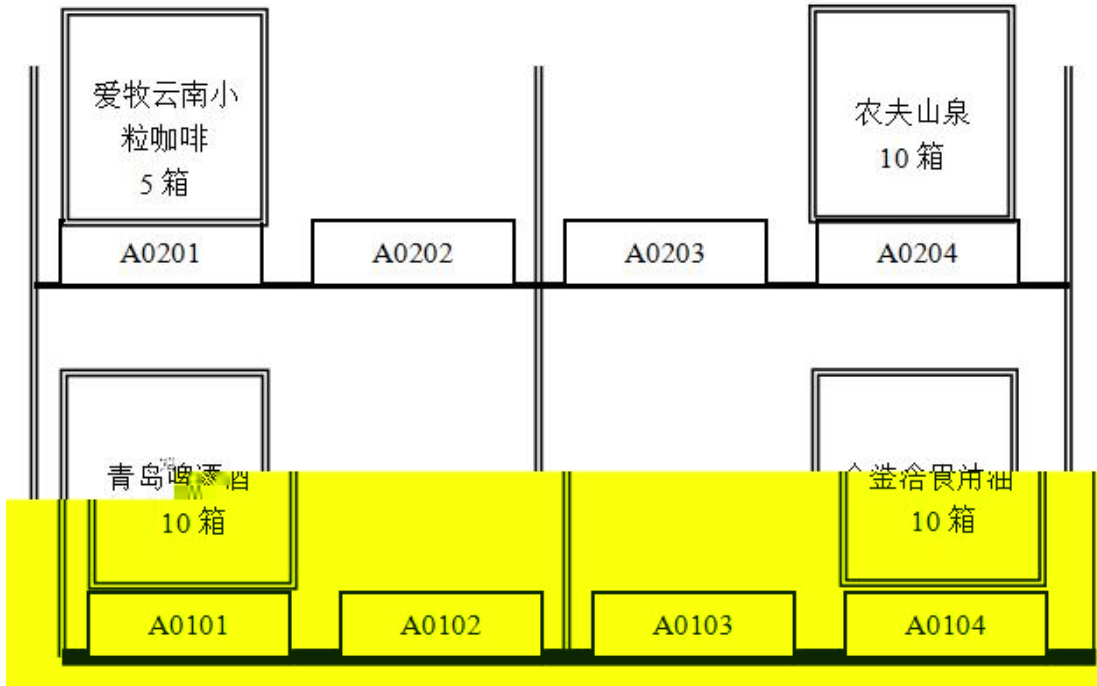

产品运输单

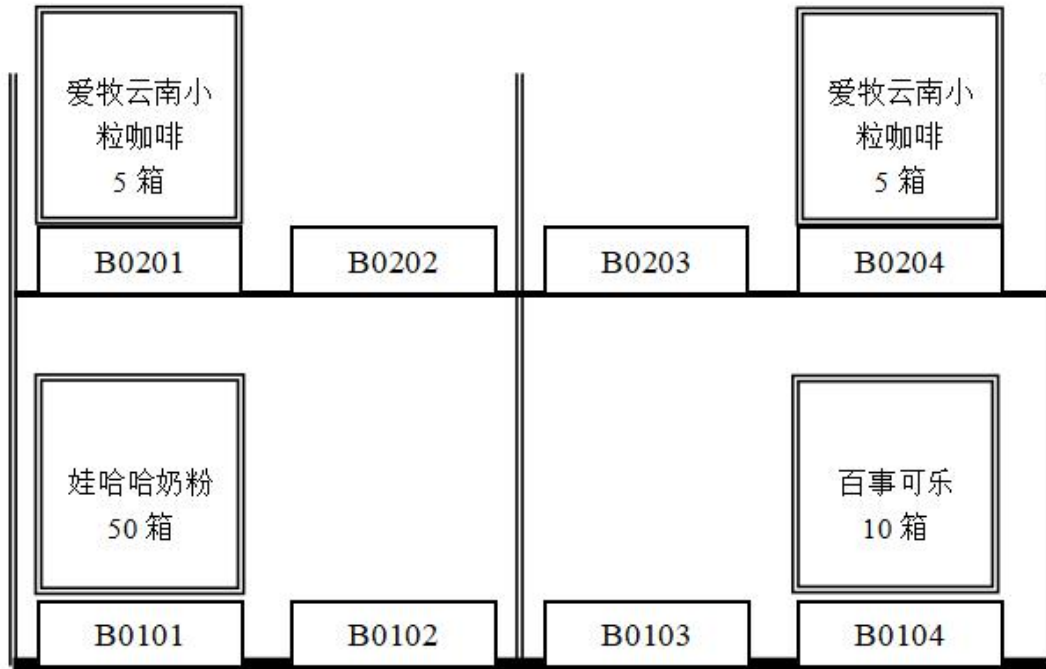
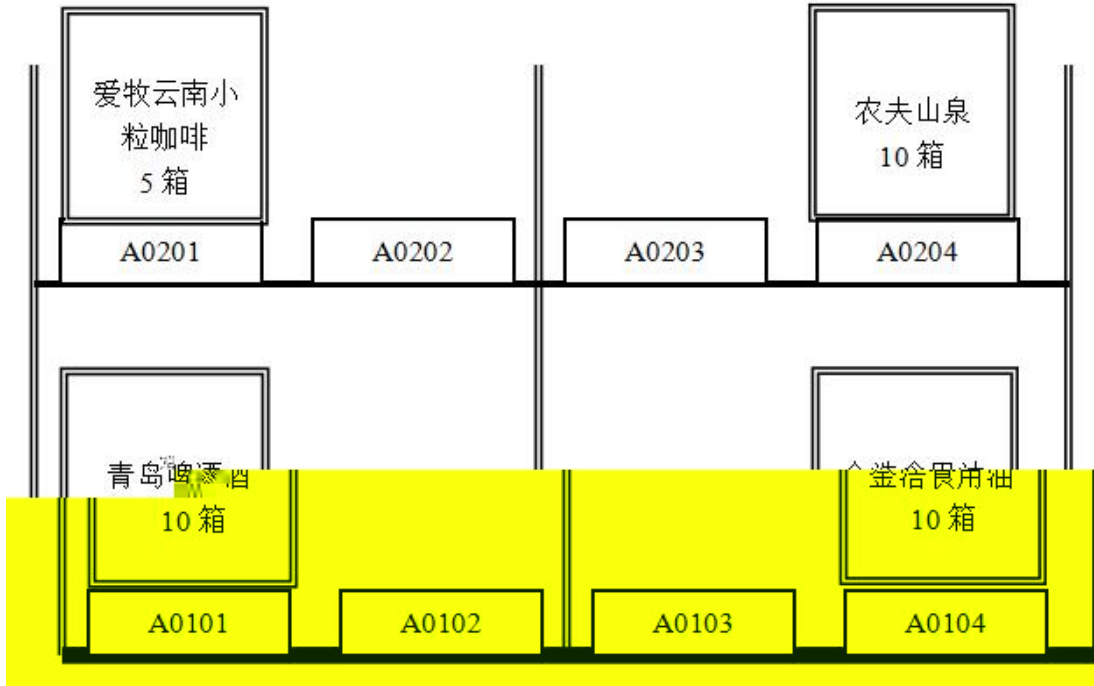

产品运输单

-
-
-
-
-
-
-
-
-

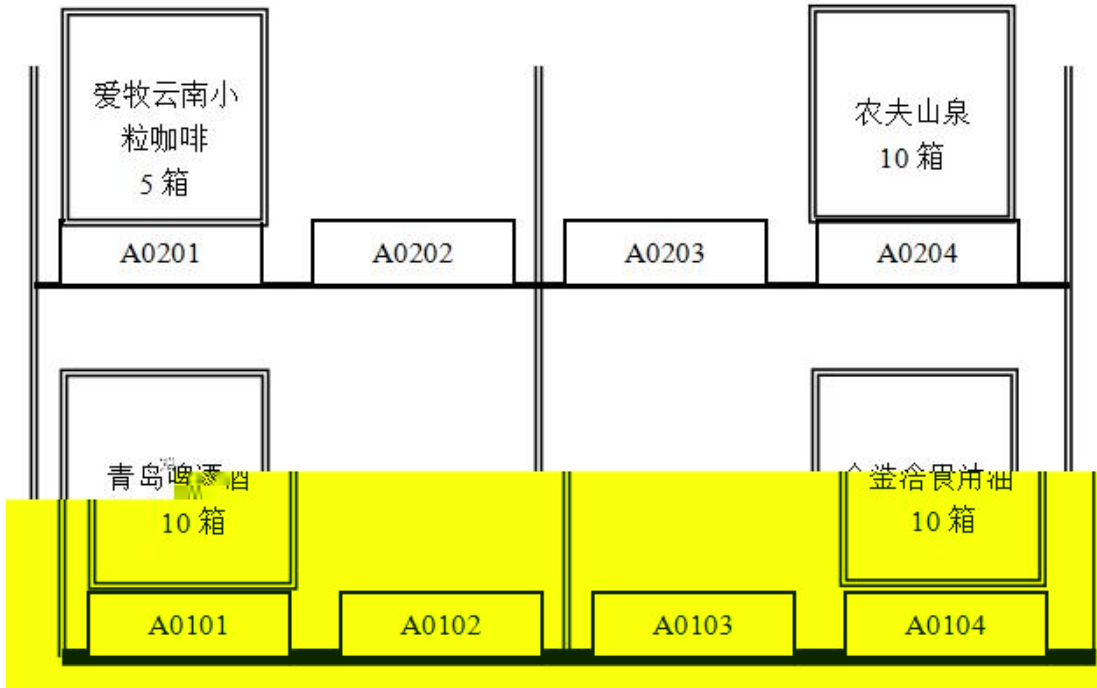

产品运输单

-
-
-
-
-
-
-
-
-

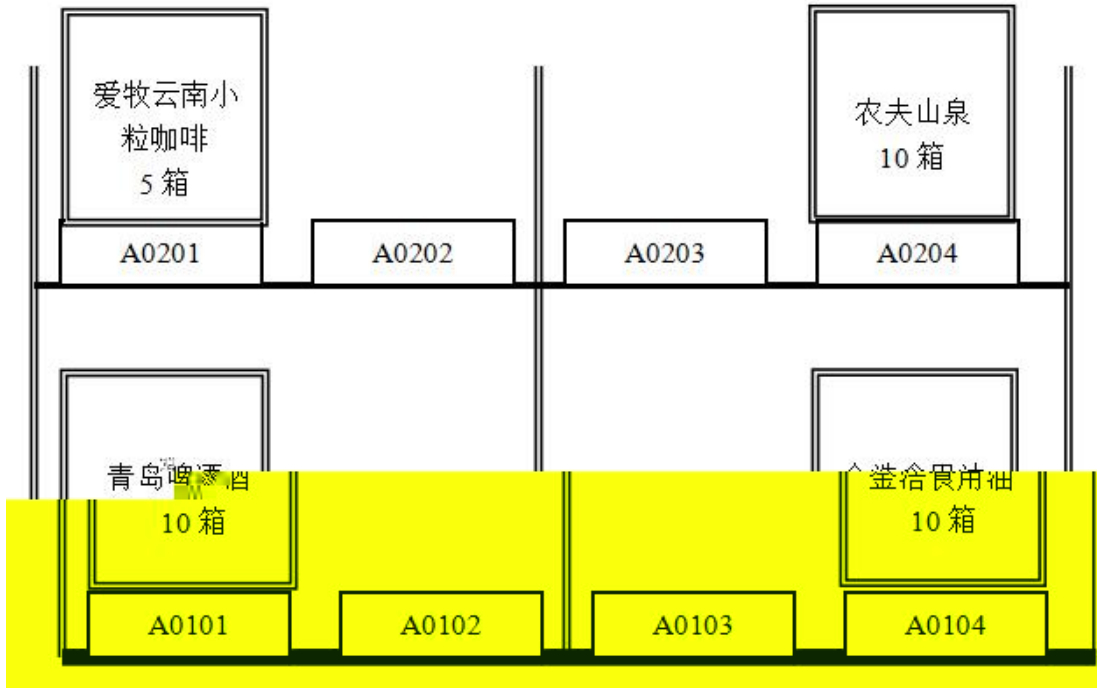

产品运输单

-
-
-
-
-
-
-
-

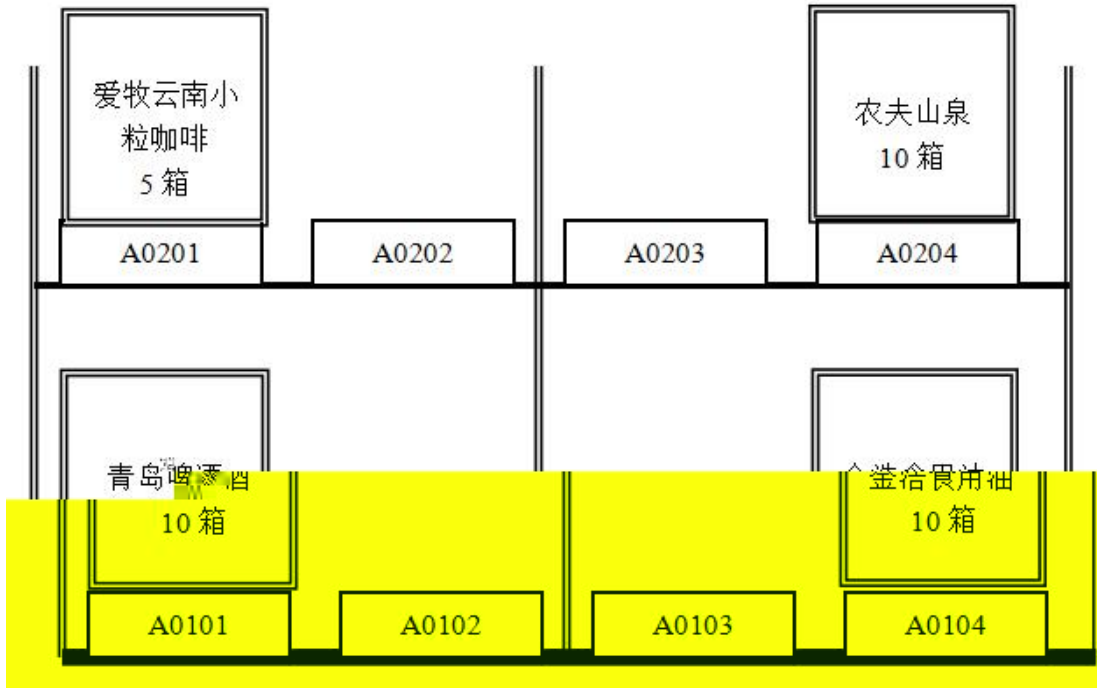

产品运输单

-
-
-
-
-
-
-
-

○

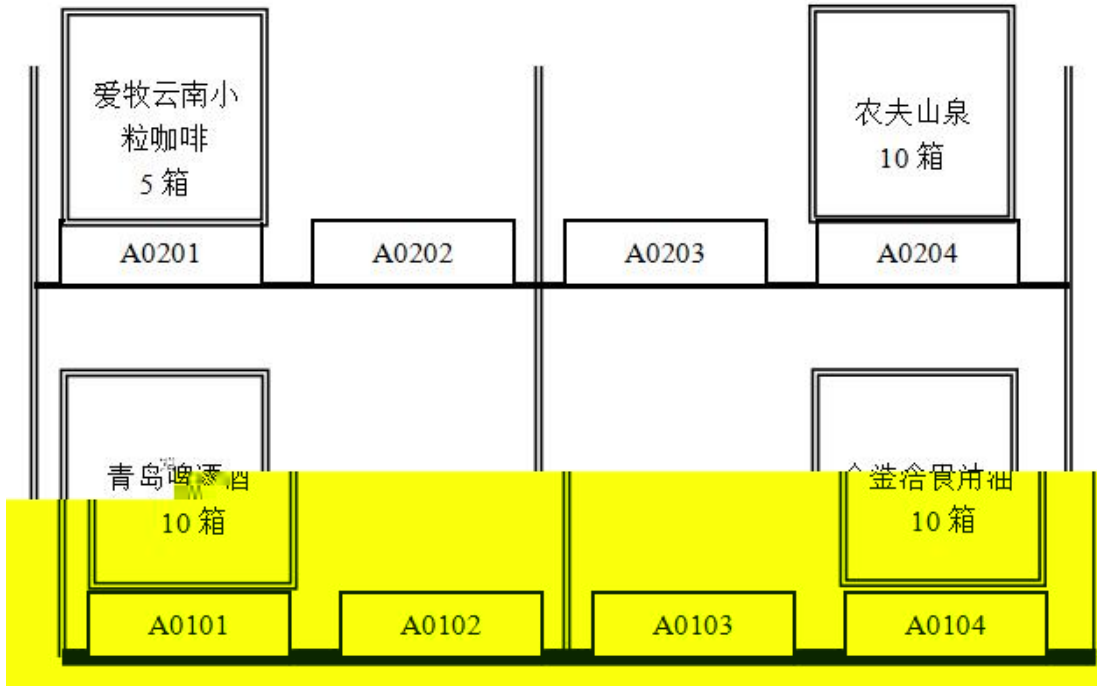



--	--	--	--	--	--

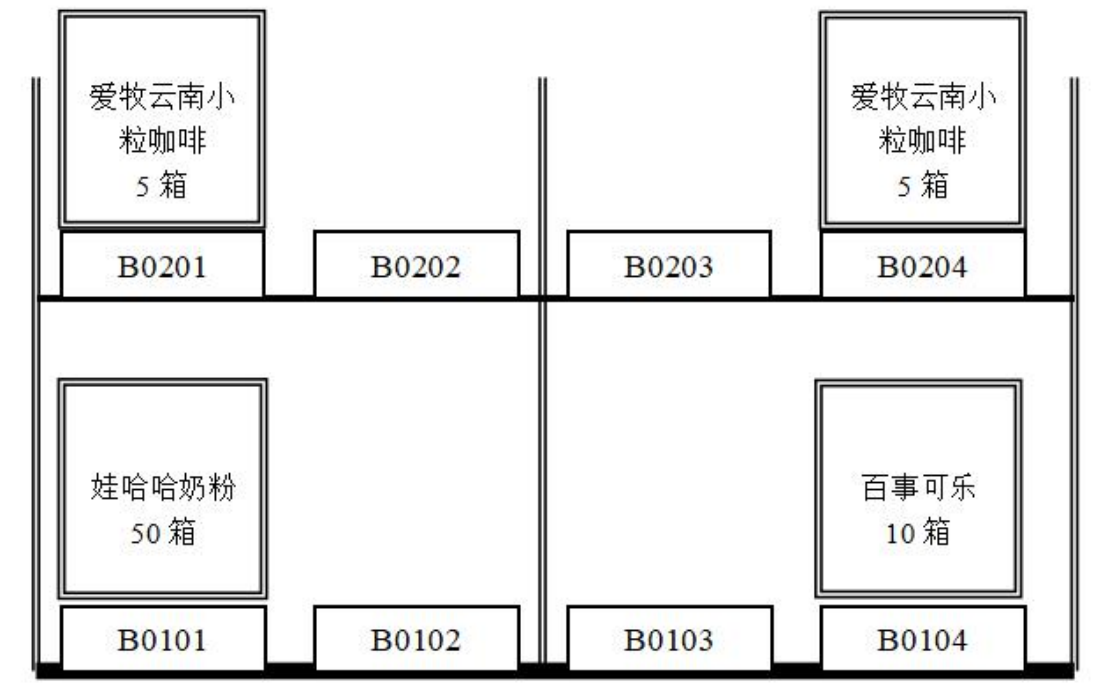
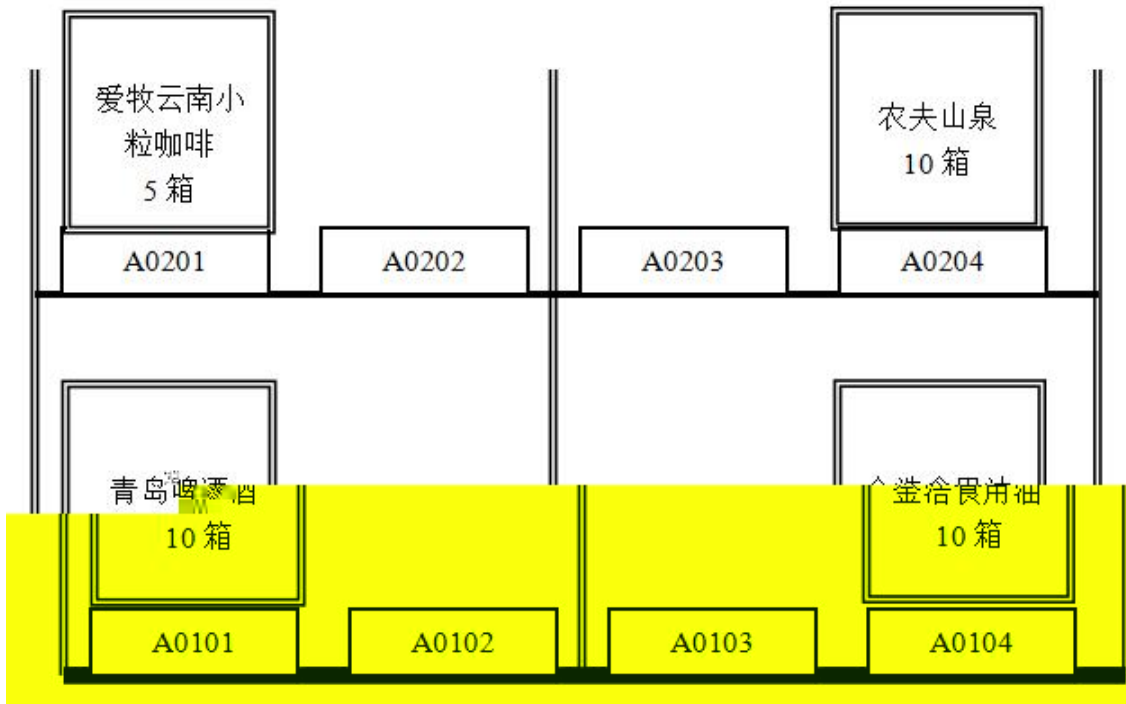

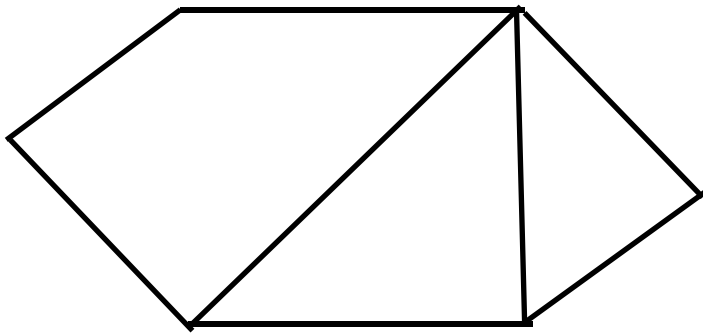

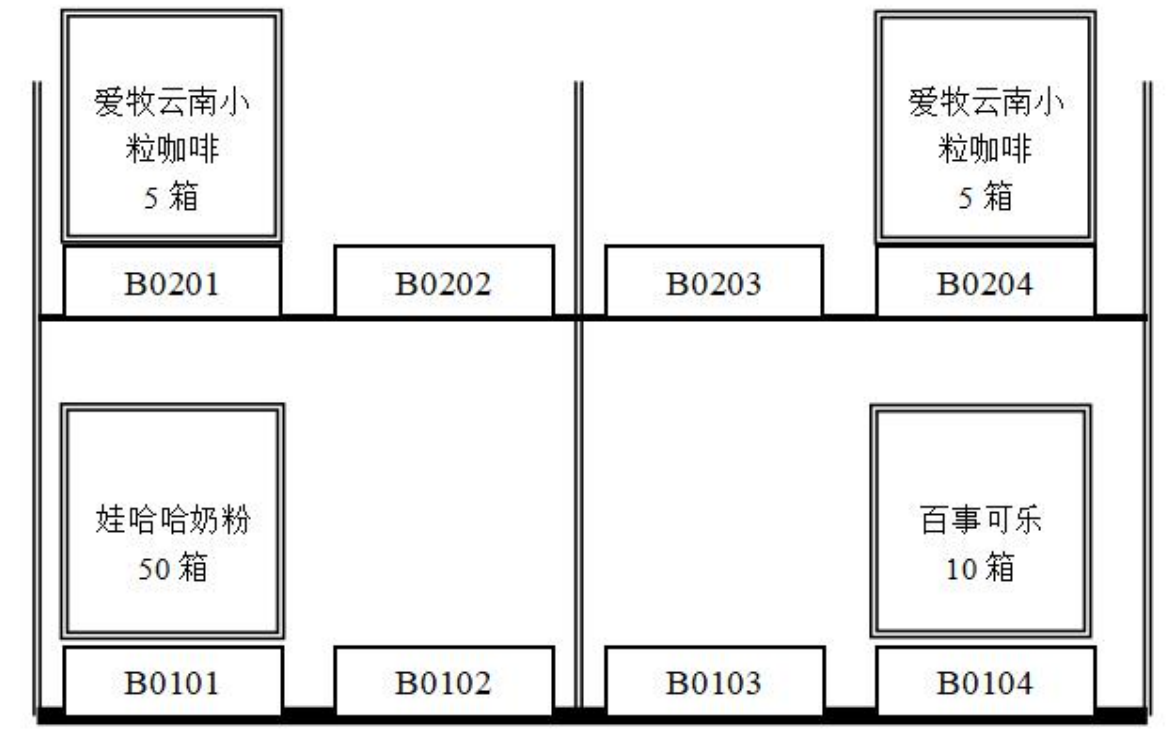
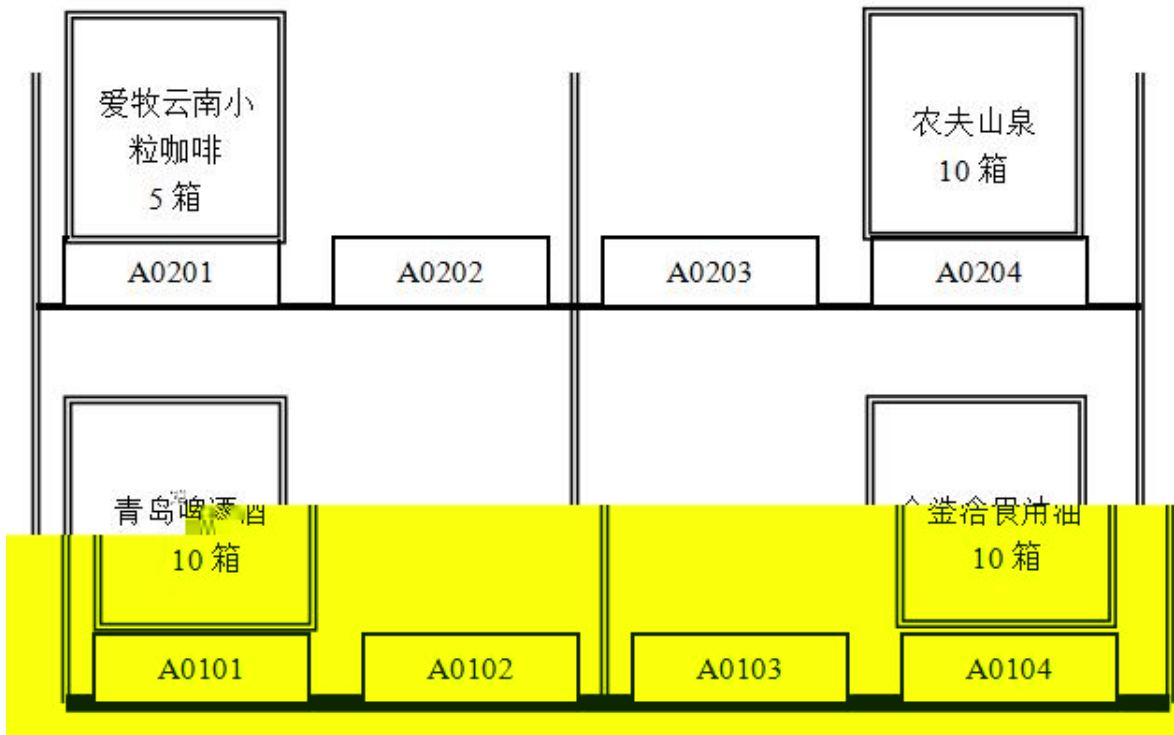



1

		---	---		

		---	---		



--- ---

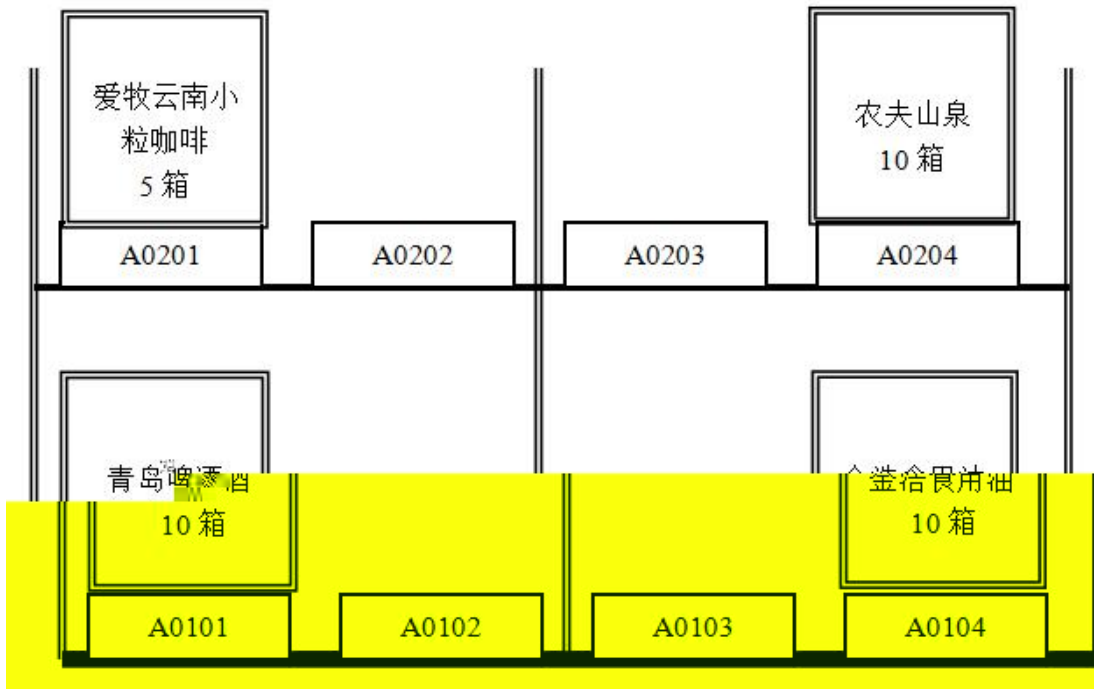



1

--	--	--	--	--	--

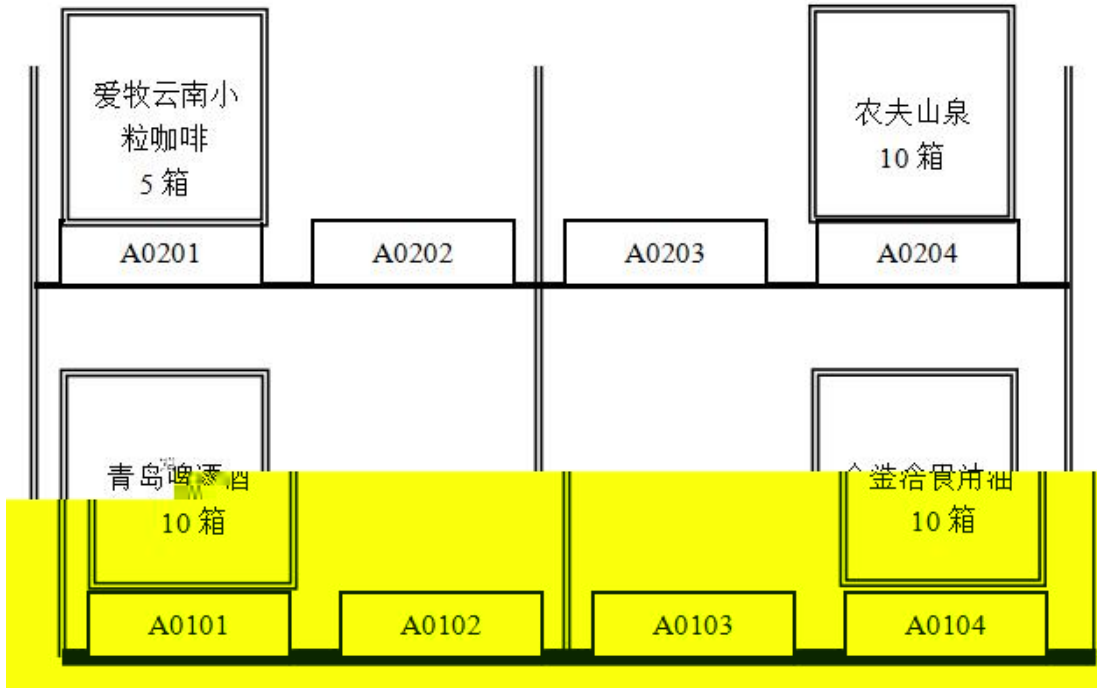



○

○

○

○

○

○

○

○

--	--

○

○

三、国际物流作业组织与管理模块

○

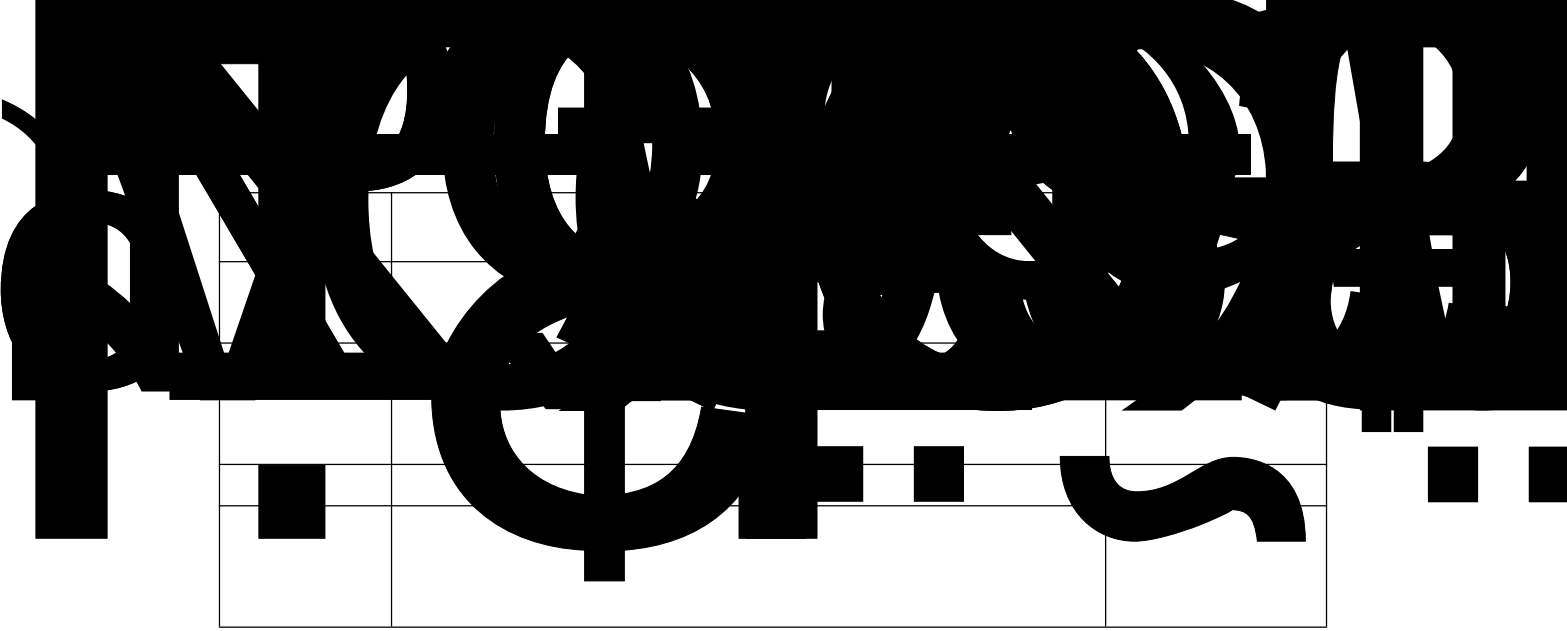



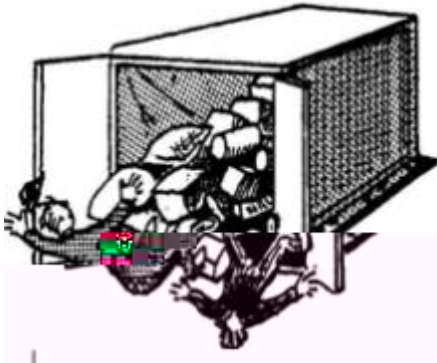
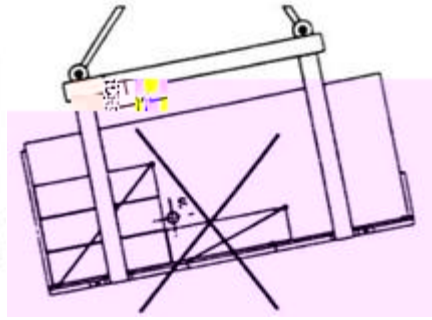

○

○
○

BEIJING	CN		BJS
Y. RENMINBI	CNY		KGS
		100	10000
		100	10000
		100	10000
		100	10000
		100	10000

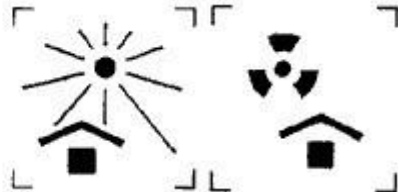

○











○

○

集装箱设备交接单
EQUIPMENT INTERCHANGE RECEIPT

OUT 出场

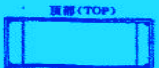
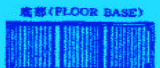
No.

用箱人/运箱人(CNTR. USER/HAULIER)			提箱地点(PLACE OF DELIVERY)		
发往地点(DELIVERED TO)			返回/收箱地点(PLACE OF RETURN)		
船名/航次(VESSEL/VOYAGE No.)			集装箱号(CNTR. No.)		尺寸/类型(SIZE/TYPE)
提单号(B/L No.)			危险品类别(IMCO CLASS)	箱封号(SEAL No.)	免费期限(FREE TIME PERIOD)
运单号(B/L No.)			运单工具牌号(TRUCK WAGON BARGE No.)		普通集装箱(GP. CNTR.)
出箱目的/状态(PPS OF GATE-OUT/STATUS)			进箱目的/状态(PPS OF GATE-IN/STATUS)		发电机(GEN. SET)
出箱日期(TIME-OUT)			出场日期(TIME-OUT)		
出场检查记录(INSPECTION AT THE TIME OF INTERCHANGE)					
普通集装箱(GP. CNTR.)		冷藏集装箱(RC. CNTR.)		特种集装箱(SPL. CNTR.)	
<input type="checkbox"/> 正常(SOUND)	<input type="checkbox"/> 异常(DEFECTIVE)	<input type="checkbox"/> 正常(SOUND)	<input type="checkbox"/> 异常(DEFECTIVE)	<input type="checkbox"/> 正常(SOUND)	<input type="checkbox"/> 异常(DEFECTIVE)
记录温度(RECORDED)		记录温度(RECORDED)		记录温度(RECORDED)	
损坏记录及代号(DAMAGE CODE)					
<div style="display: flex; justify-content: space-around;"> <div style="text-align: center;">  破损 (BROKEN) </div> <div style="text-align: center;">  凹痕 (DENT) </div> <div style="text-align: center;">  缺失 (MISSING) </div> <div style="text-align: center;">  污损 (DIRTY) </div> <div style="text-align: center;">  危标 (DGLABEL) </div> </div>					
 左侧(LIFT SIDE)		 右侧(RIGHT SIDE)		 前部(FRONT)	
 顶部(TOP)		 底部(FLOOR BASE)		 后部(REAR)	
 内部(INSIDE)					
如有异常,请注明程度及尺寸(REMARK)					
除列明者外,集装箱设备交接时完好无损,箱封完整无损。 * CONTAINER EQUIPMENT INTERCHANGED IN SOUND CONDITION AND SEAL INTACT UNLESS OTHERWISE STATED 用箱人/运箱人签署 (CONTAINER USER/HAULIER'S SIGNATURE) 码头/堆场值班员签署 (TERMINAL/DEPOT CLERK'S SIGNATURE)					
年 月 日			年 月 日		
GB/T 14126-1996 格式印制					

--	--	--	--	--	--

--	--	--

--	--	--	--	--	--

--	--	--	--	--	--

--	--	--	--	--	--	--	--

○





○

--	--	--

--	--	--	--	--	--

○

○

○

○

四、 快递物流作业组织与管理模块

--	--	--	--	--	--

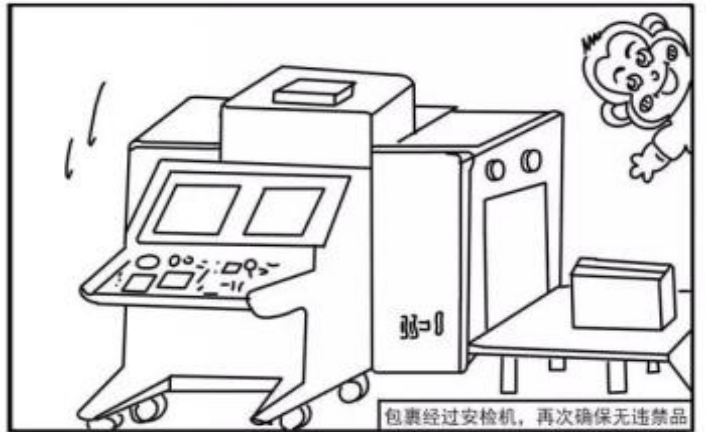

--	--	--	--	--	--

--	--	--	--	--	--

[想知道:中国成都理工大学校园快递具体在哪? 百度知道](#)

3个回答 - 提问时间: 2014年02月10日

最佳答案  均在银杏后面。宝盒、圆通、顺丰在电影院后面。中通、申通在图书馆下面。常用的是这几个。

zhidao.baidu.com/link?... 2014-02-15 - 百度快照 - 80%好评

PHOTOGRAPHY

--	--	--	--

--	--	--	--

--

